

MBC-510 SPRAY GUN

IMPORTANT: Before using this equipment, read all safety precautions and instructions. Keep for future use.

Note

This gun may be used with chlorinated solvents. Aluminum is not used in the fluid passage areas.

DESCRIPTION

The MBC-510 standard spray gun has a removable sprayhead; nickel plated brass fluid passages; a stainless steel fluid tip and needle to reduce wear; forged aluminum gun body; large air and fluid passages for high capacity use and a cartridge type air valve to minimize repairs.

Nozzle combinations are listed in Chart 1. Refer to the Spray Gun Catalog, I-2008, for information regarding air cap and fluid tip characteristics.

OPERATION

Strain material thru 60 or 90 mesh screen.

Adjust fluid pressure to deliver the desired paint volume. Adjust air pressure and flow to provide a uniform dispersion of atomized paint throughout the pattern. Keep air pressure as low as possible to minimize bounce - back and overspray. Excessive fluid flow will result in heavy center spray patterns. Inadequate flows may cause the pattern to split. See Spray Gun Guide, SB-2-001, which is available upon request, for details concerning set up of spray guns.

PREVENTIVE MAINTENANCE

To clean air cap and fluid tip, brush exterior with a stiff bristle brush. If necessary to clean cap holes, use a broom straw or toothpick. **Never use a wire or hard instrument.** This may scratch or burr holes causing a distorted spray pattern.

To clean fluid passages, remove excess material at source, then flush with a suitable solvent using a device such as the SolventSaver™ (see Accessories). Wipe gun exterior with a solvent dampened cloth. Never completely immerse in solvent as this is detrimental to the lubricants and packings.

Note

When replacing the fluid tip or fluid needle, replace both at the same time. Using worn parts can cause fluid leakage. For thinner, less viscous materials a lapped tip and needle set is recommended. See Chart 3. Also, replace the needle packing at this time. Lightly lubricate the threads of the fluid tip before reassembling. Torque to 20-25 ft. lbs. Do not over tighten the fluid tip.

CAUTION

To prevent damage to the fluid tip (5) or fluid needle (11), be sure to either 1) pull the trigger and hold while tightening or loosening the fluid tip or 2) remove fluid needle adjusting screw (32) to relieve spring pressure against needle collar.

SPRAY GUN LUBRICATION

Daily, apply two drops of •SSL-10 spray gun lube (see Accessories) at trigger bearing stud (34) and the stem of the air valve (15) where it enters the air valve assembly. The shank of the fluid needle (11) where it enters the packing nut (10) should also be oiled. The fluid needle packing (9) should be kept soft and pliable by periodic lubrication. Make sure the sprayhead (8) and retaining ring (1 or 2) threads are clean and free of foreign material. Before assembling retaining ring to sprayhead, clean the threads thoroughly, then add two drops of SSL-10 spray gun lube to threads. The fluid needle spring (31) and air valve spring (16) should be coated with a very light grease, making sure that any excess grease will not clog the air passages. For best results, lubricate the points indicated, daily.

• Material Safety Data Sheet available from DeVilbiss upon request.

- A. Trigger Points
- B. Packing
- C. Adjusting Valves
- D. Threads

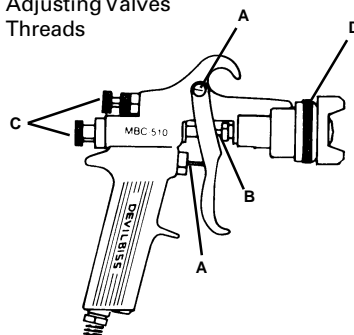

CHART 1

Nozzle Combinations						
Air Cap Sizes Order From Chart 2	Fluid Tip and Needle Sizes Order From Chart 3					
	AC	D	E	EX	FF	FX
24		P	P			P
30			P	S	P	P
58			P/S	S	P	P
62HD	P					
64HD			P			
69HD		P				
80				S		
704			P		P	
765			P		P	P
777			P		P	
797			P		P	
9000				S		

P - Pressure Feed Combination
S - Suction Feed Combination

CHART 2

Air Caps		
No. on Cap Order	Ref. Nos. (1) Air Cap with Ring	Ref. No. (3) Air Cap Less Ring
24		AV-40-24
30	MB-4039-30	
58	AV-439-58	
62HD	MB-4039-62HD	
64HD	MB-4039-64HD	
69HD	MB-4039-69HD	
80	MB-4039-80	
704		AV-1239-704
765		AV-1239-765
777		31767-777
797		AV-1239-797
9000	AV-440-9000	

SAFETY PRECAUTIONS

This manual contains information that is important for you to know and understand. This information relates to USER SAFETY and PREVENTING EQUIPMENT PROBLEMS. To help you recognize this information, we use the following symbols. Please pay particular attention to these sections.

WARNING

Important safety information - A hazard that may cause serious injury or loss of life.

Important information that tells how to prevent damage to equipment, or how to avoid a situation that may cause minor injury.

Note

Information that you should pay special attention to.

WARNING

The following hazards may occur during the normal use of this equipment. Please read the following chart before using this equipment.





HAZARD	CAUSE	SAFEGUARDS
 <p>Fire</p>	Solvent and coatings can be highly flammable or combustible especially when sprayed.	<p>Adequate exhaust must be provided to keep air free of accumulations of flammable vapors.</p> <p>Smoking must never be allowed in the spray area.</p> <p>Fire extinguishing equipment must be present in the spray area.</p>
 <p>Solvent Spray</p>	During use and while cleaning and flushing, solvents can be forcefully expelled from fluid and air passages. Some solvents can cause eye injury.	Wear eye protection.
 <p>Inhaling Toxic Substances</p>	Certain materials may be harmful if inhaled, or if there is contact with the skin.	<p>Follow the requirements of the Material Safety Data Sheet supplied by your coating material manufacturer.</p> <p>Adequate exhaust must be provided to keep the air free of accumulations of toxic materials.</p> <p>Use a mask or respirator whenever there is a chance of inhaling sprayed materials. The mask must be compatible with the material being sprayed and its concentration. Equipment must be as prescribed by an industrial hygienist or safety expert, and be NIOSH approved.</p>
 <p>Explosion Hazard - Materials</p>	Halogenated hydrocarbon solvents - for example; methylene chloride and 1, 1, 1 - Trichloroethylene are not chemically compatible with the aluminum that might be used in many system components. The chemical reaction caused by these solvents reacting with aluminum can become violent and lead to an equipment explosion.	The MBC-510 can be used with these solvents. However, aluminum is widely used in other spray application equipment - such as material pumps, regulators, valves and cups. Check all equipment items before use and make sure they can also be used safely with these solvents. Read the label or data sheet for the material you intend to spray. If in doubt as to whether or not a coating or cleaning material is compatible, contact your material supplier.
General Safety	Improper operation or maintenance of equipment.	Operators should be given adequate training in the safe use & maintenance of the equipment (in accordance with the requirements of NFPA-33, Chapter 15). Users must comply with all local & national codes of practice & insurance company requirements governing ventilation, fire precautions, operation, maintenance and housekeeping. These are OSHA Sections 1910.94 and 1910.107 and NFPA-33.
Cumulative Trauma Disorders ("CTD's") CTD's, or musculo-skeletal disorders, involve damage to the hands, wrist, elbows, shoulders, neck and back. Carpal tunnel syndrome and tendinitis (such as tennis elbow or rotator cuff syndrome) are examples of CTD's.	<p>Use of hand tools may cause cumulative trauma disorders ("CTD's").</p> <p>CTD's when using hand tools, tend to affect the upper extremities. Factors which may increase the risk of developing a CTD include:</p> <ol style="list-style-type: none"> 1. High frequency of the activity. 2. Excessive force, such as gripping, pinching, or pressing with the hands and fingers. 3. Extreme or awkward finger, wrist, or arm positions. 4. Excessive duration of the activity. 5. Tool vibration. 6. Repeated pressure on a body part. 7. Working in cold temperatures. <p>CTD's can also be caused by such activities as sewing, golf, tennis, bowling, to name a few.</p>	Pain, tingling, or numbness in the shoulder, forearm, wrist, hands or fingers, especially during the night, may be early symptoms of a CTD. Do not ignore them. Should you experience any such symptoms, see a physician immediately. Other early symptoms may include vague discomfort in the hand, loss of manual dexterity, and nonspecific pain in the arm. Ignoring early symptoms and continued repetitive use of the arm, wrist & hand can lead to serious disability. Risk is reduced by avoiding or lessening factors 1-7.

CHART 3

Fluid Tips and Needles						
If this is No. on Tip Order →	Ref. No. 4 Sprayhead Assy.	Ref. No. 5 Fluid Tip & Gasket Assy.	Ref. No. 11 Fluid Needle	Ref. No. 39 Lapped Tip & Needle Assy. 404 S/S	Optional 303 S/S Tip Needle U.H.M.W. Poly.	
					No. on Tip 5	Ref. No. 39
AV-2115-AC	————	AV-650-AC	MBC-496-C			
AV-2115-D	P-MBC-430-D	AV-650-D	MBC-496-DEX	MBC-4395-D	AV-4915-D	MBC-4397-D
AV-2115-E	P-MBC-430-E	AV-650-E	MBC-444-E	MBC-4395-E	AV-4915-E	MBC-4397-E
AV-2115-EX	P-MBC-430-EX	AV-650-EX	MBC-496-DEX			
AV-2115-FF	P-MBC-430-FF	AV-650-FF	MBC-444-FF	MBC-4395-FF	AV-4915-FF	MBC-4397-FF
AV-2115-FX	P-MBC-430-FX	AV-650-FX	MBC-444-FX	MBC-4395-FX		

PARTS LIST

Ref. No.	Replacement Part No.	Description	Individual Parts Required
1	See Chart 2	Air Cap/Retaining Ring	1
2	MBC-368	Retaining Ring for Ref. No. 3 & 4	1
3	See Chart 2	Air Cap Less Retaining Ring	1
4	See Chart 3	Sprayhead Assembly	1
5	See Chart 3	Fluid Tip and Gasket Assembly	1
•6	AV-1-K5	Gasket Kit (Kit of 5)	1
7	MBC-1225	Baffle	1
8	P-MBC-402	Sprayhead Body	1
•9	A-23-K10	Packing Kit (Kit of 10)	1
10	MB-19-K5	Packing Nut Kit (Kit of 5)	1
11	See Chart 3	Fluid Needle	1
•12	JGA-14-K25	Snap ring Kit (Kit of 25)	1
•13	JGA-15-K25	Washer Kit (Kit of 25)	1
•14	JGS-26-K25	U-Cup Kit (Kit of 25)	1
•15	JGS-431-K25	Air Valve Kit (Kit of 25)	1
•16	MBD-12-K25	Spring Kit (Kit of 25)	1
•17	JGS-72-K10	Gasket Kit (Kit of 10)	1
18	JGS-449-1	Valve Assembly	1
•19	MBC-1226-K10	Gasket Kit (Kit of 10)	1
20	MBC-67	Locking Bolt	1
21	MBC-498-1	Fan Adjustment Valve	1
22	---	Washer	1
•23	---	Packing	1
24	---	Packing Nut	1
25	---	Knob	1
•26	---	Screw	1
27	MBC-415	Cylinder Assembly	1
•28	CV-5-K5	Gasket Kit (Kit of 5)	1
29	---	Cylinder	1
30	MBC-33	Plunger	1
•31	MBC-29-K5	Spring (Kit of 5)	1
32	MBC-39	Screw	1
33	P-MB-51	Air Inlet Adapter 1/4" NPS	1
34	---	Trigger Bearing Stud	1
•35	---	Screw	1
36	JGS-478	Stud and Screw Kit (3 studs, 5 screws in kit)	1
37	JGS-477-1	Trigger, Stud and Screw Kit (Kit includes 1 each)	1
#38	P-MBC-428-3	Spray gun less spray head	1
†39	See Chart 3	Lapped Tip and Needle Assembly (Not shown)	1

• A quantity of necessary parts is included in repair kit KK-4058-1 for complete gun repair and should be kept on hand for service convenience.

Ref. No. 38 includes Ref. Nos. 12-37.

† Ref. No. 39 includes Ref. Nos. 5, 6 and 11.



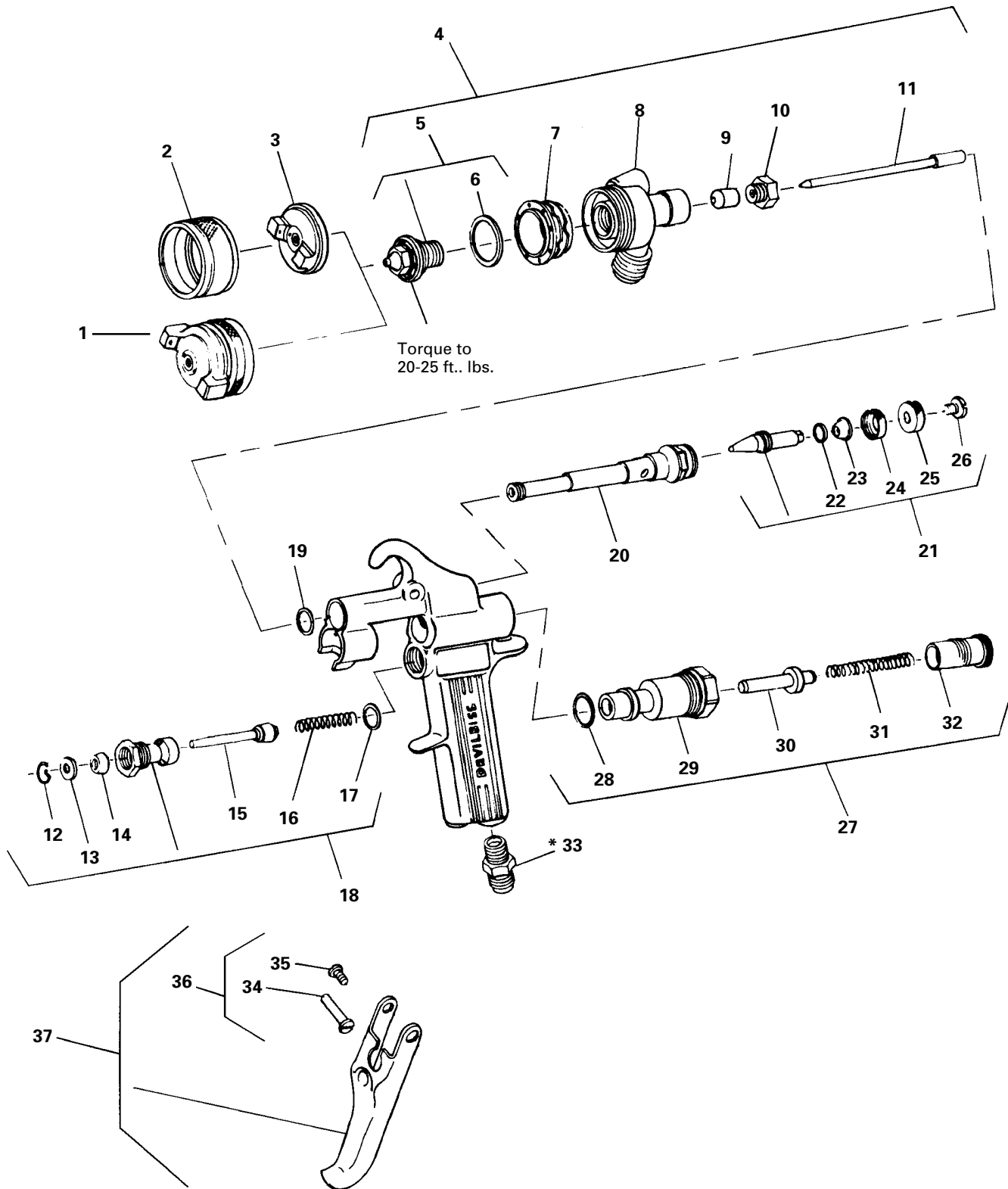

Suffixes -K5 and -K10 designates kits of multiple parts.

Example: AV-1-K5 is a kit of 5 gaskets.











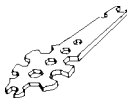
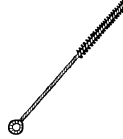
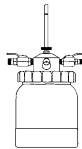
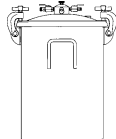

*Apply thread sealant (i.e. Loctite 242, blue or equal) on threads.

TROUBLESHOOTING

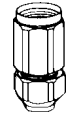
CONDITION	CAUSE	CORRECTION
Heavy top or bottom pattern 	Horn holes plugged. Obstruction on top or bottom of fluid tip. Cap and/or tip seat dirty.	Clean. Ream with non-metallic point. Clean. Clean.
Heavy right or left side pattern 	Left or right side horn holes plugged. Dirt on left or right side of fluid tip. Remedies for the top-heavy, bottom-heavy, right-heavy and left-heavy patterns: 1) Determine if the obstruction is on the air cap or the fluid tip. Do this by making a test spray pattern. Then, rotate the cap one-half turn and spray another pattern. If the defect is inverted, obstruction is on the air cap. Clean the air cap as previously instructed. 2) If the defect is not inverted, it is on the fluid tip. Check for a fine burr on the edge of the fluid tip. Remove with #600 wet or dry sand paper. 3) Check for dried paint just inside the opening. Remove paint by washing with solvent.	Clean. Ream with non-metallic point. Clean.
Heavy center pattern 	Too much material. Material too thick.	Reduce fluid flow on suction guns. Reduce fluid pressure on pressure feed guns. Thin to proper consistency.
Split spray pattern 	Not enough material.	Reduce air pressure or increase fluid flow by turning fluid needle adjusting screw counter clockwise on suction feed, increase fluid pressure on pressure feed guns.
Jerky or fluttering spray 	*Loose or damaged fluid tip/seat. Insufficient fluid in cup or pressure tank. Gun (with cup) tipped at excessive angle. Obstructed fluid passage or hose. Loose or cracked fluid tube in cup or tank. Too heavy fluid for suction feed. Dry or worn packing (14) or loose packing nut (15).	Tighten or replace. Fill cup or tank. Do not tip excessively or rotate fluid tube. Clean. Tighten or replace. Change to pressure feed. Lubricate or replace. Tighten.
Unable to get round spray	Fan adjustment screw not seating properly. Air cap retaining ring loose.	Clean or replace. Tighten.
Will not spray	No air pressure at gun. Internal mix or pressure feed air cap and tip used with suction feed. Fluid pressure too low with internal mix cap and pressure tank. Fluid needle adjusting screw not open enough. Fluid too heavy for suction feed.	Check air supply and air lines. Change to proper suction feed air cap and tip. Increase fluid pressure at tank. Open fluid needle adjusting screw. Thin material or change to pressure feed.
Fluid leaking from packing nut	Packing nut loose. Packing worn or dry	Tighten, do not bind needle. Replace or lubricate.
Dripping from fluid tip	Dry packing. Sluggish needle. Tight packing nut. Sprayhead misaligned, causing needle to bind.	Lubricate. See "Preventive Maintenance". Lubricate. See "Preventive Maintenance". Adjust. See "Preventive Maintenance". Tap all around sprayhead with wooden mallet and retighten locking bolt.

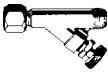
*Most common problem.

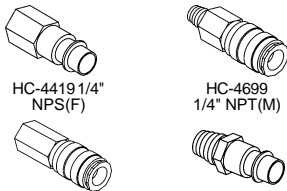
ACCESSORIES

<p>WR-103 Wrench</p>  <p>Contains all necessary tip, hose and nut sizes used on or with gun.</p>	<p>42884-214-K5 3/8" 42884-215-K10 5/8" Cleaning Brushes</p>  <p>These brushes are helpful in cleaning threads and recesses of gun body.</p>	<p>HD-503 SolventSaver™ Hose/Gun Cleaner</p>  <p>2 Qt. & 2-1/2 Gal hose/gun cleaner used to clean the inside of hose, fluid passageways of gun & other paint equipment.</p>	<p>QMGZ SolventSaver™ Hose/Gun Cleaners</p>  <p>2 Gallon galvanized tank used to clean the inside of hose and material passages of the gun.</p>	<p>JGA-156-K10 Spring Clip</p>  <p>Joins any single piece DeVilbiss air cap with latest version MBC-368 or MSA-1 retaining ring. Helps prevent parts loss and provides easier assembly.</p>	<p>Spray Gun Lube SSL-10 (2 oz. bottle)</p>  <p>Compatible with all paint materials: contains no silicone or petroleum distillates to contaminate paint. MSDA sheet available upon request.</p>
<p>HAV-500 OR HAV-501 Adjusting Valve (HAV-501 SHOWN)</p>  <p>HAV-500 does not have pressure gage. Use to control air usage at gun.</p>	<p>VS-531 Low Pressure Strainers</p>  <p>The VS-531 Low Pressure Fluid Strainer provides a final filter for trapping foreign particles in the paint supply.</p>	<p>MB-135-K9 Leather Packings</p>  <p>Optional packings used commonly with abrasive materials. Use (3) in place of A-23 packing.</p>	<p>MBC Conversion Kit KK-5026 - This conversion kit contains the components required to convert a standard MBC-510 to an MBC-ZINC gun. Used to apply organic and inorganic zinc materials.</p>		<p>MSP-524 Twin Cartridge, Paint Spray Respirator</p>  <p>NIOSH-Certified (TC-84A-1623 for respiratory protection in atmospheres not immediately dangerous to life.)</p>
<p>P-H-5516 Air Adjusting Valve</p>  <p>Enables user to control and reduce air usage at the gun. Ideal for low pressure spraying.</p>	<p>HAF-507 Whirlwind™ In-Line Air Filter</p>  <p>Removes water, oil, and debris from the air line.</p>	<p>Quick Disconnect Approved for HVLP Guns (Air) High Flow Ball and Ring Type</p>  <p>HC-4419 1/4" NPS(F) HC-4699 1/4" NPT(M) HC-4700 1/4" NPT(M) HC-1166 1/4" NPT(M)</p>	<p>KB-555 (Aluminum) & KB-545-SS (S/S) 2 qt. Pressure Feed Cup With Regulator</p>  <p>Provides greater degree of control over cup fluid pressure.</p>		

WARRANTY

This product is covered by DeVilbiss' 1 Year Limited Warranty. See SB-1-000 which is available upon request.

DeVILBISS WORLDWIDE SALES AND SERVICE LISTING – www.devilbiss.com

INDUSTRIAL FINISHING

DeVilbiss has authorized distributors throughout the world. **FOR TECHNICAL ASSISTANCE OR THE DISTRIBUTOR NEAREST YOU, CALL TOLL FREE 1-888-992-4657 (U.S.A. AND CANADA ONLY). FOR LOCAL CALLS, SEE LISTING BELOW.**

U.S.A./Canada Sales & Customer Service Office
 GLENDALE HEIGHTS, IL 60139

Address
 195 Internationale Blvd.

Telephone No.
 (360) 237-5000
 Toll Free Fax No. 1-877-790-6965