

FLG-513, FLG-606 AND FLG-626 SPRAY GUN

IMPORTANT: Before using this equipment, read all safety precautions on page 2 and instructions. Keep for future use.

DESCRIPTION - MODEL FLG-606 & FLG-626 SPRAY GUNS

The FLG-606 and FLG-626 are light weight, general purpose suction feed spray guns for both conventional and HVLP spraying applications suitable for use with a wide variety of common coating materials. These models include the TGC-545 suction cup. The FLG-513 is a pressure feed HVLP spray gun.

WARNING

Halogenated hydrocarbon solvents - for example; 1, 1, 1-trichloroethane and methylene chloride - can chemically react with the aluminum in this gun and cause an explosion hazard. Read the label or data sheet for the material you intend to spray. Do not use spray materials containing these solvents with this spray gun.

IMPORTANT: This gun may be used with most common coating and finishing materials. It is designed for use with mildly corrosive and non-abrasive materials. If used with other high corrosive or abrasive materials, it must be expected that frequent and thorough cleaning will be required and the necessity for replacement of parts will be increased.

OPERATION

Strain material thru 60 or 90 mesh screen.

Model FLG-606:

The No. 1 (conventional) air cap requires an air supply at the gun inlet of approximately 45 psi, measured with the trigger pulled and can be operated from a 3 H.P. compressor.

HVLP Models FLG-513 and FLG-626:

The No. 3 (HVLP) air cap requires an air supply at the gun inlet of 23 psi max., measured with the trigger pulled and can be operated from a 3 H.P. compressor. This will give a maximum of 10 psi at the air cap.

This gun was manufactured to provide maximum transfer efficiency by limiting air cap pressure to 10 psi (complies with rules issued by SCAQMD and other air quality authorities).

This gun will produce approximately 10 psi cap pressure at 23 psi inlet pressure, as measured at the gun inlet. An air cap test kit (see ACCESSORIES) should be used to insure 10 psi cap pressure is not exceeded.

Adjust fluid pressure to deliver the desired paint volume. Adjust air pressure and fluid flow to provide a uniform dispersion of atomized paint throughout the pattern. Keep air pressure as low as possible to minimize bounce - back and overspray. Excessive air pressure will result in split patterns. Low air pressure will result in heavy centered patterns and poor atomization. Excessive fluid flow will result in heavy center spray patterns. Inadequate fluid flows may cause the pattern to split. See Spray Gun Guide, SB-2-001, which is available upon request, for details concerning set up of spray guns.

PREVENTIVE MAINTENANCE

To clean air cap and fluid tip, brush exterior with a stiff bristle brush. If necessary to clean cap holes, use a broom straw or toothpick if

possible. If a wire or hard instrument is used, extreme care must be used to prevent scratching or burring of the holes which will cause a distorted spray pattern.

To clean fluid passages, remove excess material at source, then flush with a suitable solvent. Wipe gun exterior with a solvent dampened cloth. Never completely immerse in solvent as this is detrimental to the lubricants and packings.

Note

When replacing the fluid tip or fluid needle, replace both at the same time. Using worn parts can cause fluid leakage. Using the supplied fluid tip tool (16), tighten fluid tip hand tight.

CAUTION

To prevent damage to the fluid tip (3) or fluid needle (6), be sure to either 1) pull the trigger and hold while tightening or loosening the fluid tip or 2) remove fluid needle adjusting screw (15) to relieve spring pressure against needle collar.

Spray Gun Lubrication

Daily, apply a drop of SSL-10 spray gun lube at trigger bearing stud (11) and the stem of the air valve (17) where it enters the air valve assembly (21). The shank of the fluid needle (6) where it enters the packing nut (8) should also be oiled. The fluid needle packing (9) should be kept soft and pliable by periodic lubrication. Make sure the baffle (5) and retaining ring (1) threads are clean and free of foreign matter. Before assembling retaining ring to baffle, clean the threads thoroughly, then add two drops of SSL-10 spray gun lube to threads. The fluid needle spring (14) and air valve spring (18) should be coated with a very light grease, making sure that any excess grease will not clog the air passages. For best results, lubricate the points indicated, daily.

- A. Trigger Points
- B. Packing
- C. Adjusting Valves
- D. Baffle Threads

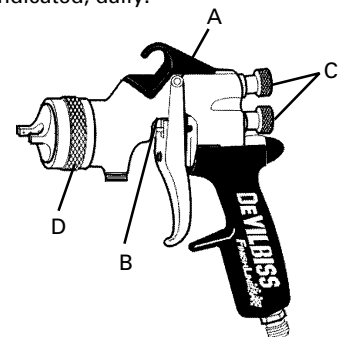

Figure 1

DESCRIPTION - MODEL TGC-545 CUP

This one quart capacity drip free suction cup has a unique, two position valve which permits selection of either a drip free spraying mode or a conventional open vent mode.

In the drip free position, air is directed through the vent in the lid to a channel beneath the lid gasket before entering the cup at the valve. This allows the cup to be tilted when full without dripping paint through the vent. The cup can also be inverted while spraying without leaking.

The open position isolates the channel and opens a direct vent into the cup.

(Continued on page 3)

SAFETY PRECAUTIONS

This manual contains information that is important for you to know and understand. This information relates to USER SAFETY and PREVENTING EQUIPMENT PROBLEMS. To help you recognize this information, we use the following symbols. Please pay particular attention to these sections.



Important safety information - A hazard that may cause serious injury or loss of life.





Important information that tells how to prevent damage to equipment, or how to avoid a situation that may cause minor injury.

Note

Information that you should pay special attention to.

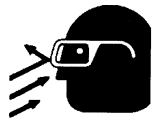

The following hazards may occur during the normal use of this equipment. Please read the following chart before using this equipment.

HAZARD	CAUSE	SAFEGUARDS
<p>Fire</p> 	<p>Solvent and coatings can be highly flammable or combustible especially when sprayed.</p>	<p>Adequate exhaust must be provided to keep air free of accumulations of flammable vapors.</p> <p>Smoking must never be allowed in the spray area.</p> <p>Fire extinguishing equipment must be present in the spray area.</p>
<p>Solvent Spray</p> 	<p>During cleaning and flushing, solvents can be forcefully expelled from fluid and air passages. Some solvents can cause eye injury.</p>	<p>Wear eye protection.</p>
<p>Inhaling Toxic Substances</p> 	<p>Certain materials may be harmful if inhaled, or if there is contact with the skin.</p>	<p>Follow the requirements of the Material Safety Data Sheet supplied by your coating material manufacturer.</p> <p>Adequate exhaust must be provided to keep the air free of accumulations of toxic materials.</p> <p>Use a mask or respirator whenever there is a chance of inhaling sprayed materials. The mask must be compatible with the material being sprayed and its concentration. Equipment must be as prescribed by an industrial hygienist or safety expert, and be NIOSH approved.</p>
<p>Explosion Hazard - Incompatible Materials</p> 	<p>Halogenated hydrocarbon solvents - for example; methylene chloride and 1, 1, 1 - Trichlorethylene are not chemically compatible with the aluminum that might be used in many system components. The chemical reaction caused by these solvents reacting with aluminum can become violent and lead to an equipment explosion.</p>	<p>Guns with stainless steel internal passageways may be used with these solvents. However, aluminum is widely used in other spray application equipment - such as material pumps, regulators, valves, and this gun and cup. Check all equipment items before use and make sure they can also be used safely with these solvents. Read the label or data sheet for the material you intend to spray. If in doubt as to whether or not a coating or cleaning material is compatible, contact your material supplier.</p>

The position of the valve is indicated by alignment of the hole in the valve slot with the marks cast on the lid. These positions are identified as on the lid as "O" for vent open and "D/F" for drip free.

OPERATION

Open Vent Mode "O" - To operate in the open vent mode, rotate the valve with a screwdriver or coin so that the hole in the valve slot is aligned with the "O" on the lid. See Figure 2.

If the valve slot hole should plug while operating in the "O" vent mode, use a pointed tool such as a nail or drill bit to probe through the valve slot hole to clear away the obstruction.

Figure 2 - Open Vent Mode

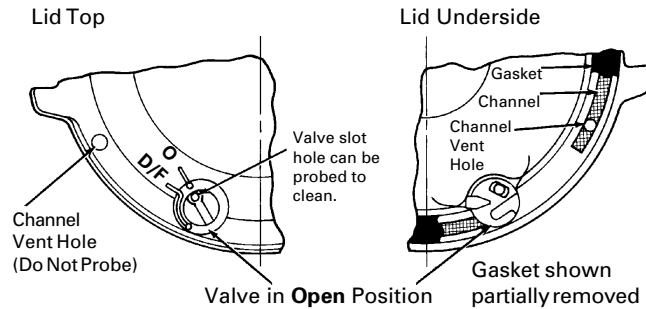

Drip Free Mode "D/F" - To operate in the drip free mode, rotate the valve with a screwdriver or coin so that the hole in the valve slot is aligned with the "D/F" on the lid. See Figure 3.

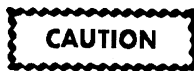

Do not probe through the valve slot hole while the valve is in D/F position. These holes are sealed by lid gasket and damage could result. See Figs. 2 & 3.

Valve Movement

Do not forcibly rotate the valve. If it will not move freely, soak in solvent or remove the lid assembly from the cup and press down on the top of the valve until it breaks free. The valve has free travel vertically of about 1/8". This can be used to push out the lid gasket.

Figure 3 - Drip Free Mode

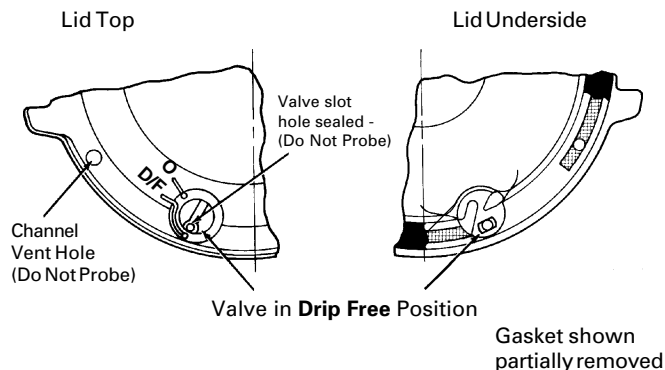

INSTALLATION

1. Position yoke at right angle to gun body with vent hole in lid toward rear and lever of cam (26) toward front of gun.
2. Fasten cup lid assembly to gun by attaching nut (25), see Figure 5, to fluid inlet nipple on gun. Tighten nut with wrench only until snug.
3. Strain material to be sprayed through a 60-90 mesh screen before pouring into cup.
4. Engage pins on cup into yoke and tighten yoke by moving lever of cam clockwise.

MAINTENANCE

Lid Repair/Replacement:

1. To replace a damaged part, use a 5/16" Allen wrench to loosen and remove adapter (24), nut (25) and yoke and cam (26). Lid and tube assembly are now loose for replacement.
2. Replace damaged parts on the lid and tube assembly. The cam lever should be located on opposite side of lid from valve (27).

3. Apply sealant (Loctite #262) to the first two full threads of adapter. Insert threaded end of adapter (24) into open end of nut (25).
4. Install adapter (24) and nut (25) in top of lid and tube assembly. Use a 5/16" Allen wrench to tighten firmly (10-12 foot pounds).

Valve and Lid Gasket Replacement:

1. To remove a damaged valve (27) or lid gasket (28), press down on top of valve until it breaks free. The valve pushes the lid gasket from the seat. The lid gasket may now be removed from the lid. Continue pressing hard on the valve to remove it from the lid.
2. Install replacement valve (27) through bottom of lid so that the valve tab is toward center of lid. Snap in place. If necessary, use a plastic mallet or screwdriver handle to tap the valve in place. Press the lid gasket (28) firmly in the lid using the end of a crescent wrench handle. Insert the side with the black marks first.

CLEANING

General: For routine cleaning, it is not necessary to remove the lid gasket. It is not necessary or desirable to remove the valve for any cleaning procedure. The valve can be depressed from the outside to assist in removal of the gasket for gasket replacement or when cleaning dried paint from the channel. The valve should not be forced past the shoulder which retains it in the lid except for replacement.

The cam and mating surfaces on the lid and yoke normally don't require removal for cleaning. Spraying some materials containing Teflon® or similar materials can necessitate more frequent cleaning and possible disassembly of the cam. The overspray containing Teflon® can build up on the cam and mating surfaces causing a condition where the cam may loosen during use.

Note

Clean cam and mating surface on lid with a solvent soaked Scotch™ pad and blow dry. If cam loosening persists, removal of the yoke and cam will be required for more thorough cleaning of these parts. Again, use a solvent soaked Scotch™ pad for this purpose. Reassemble lid.

Air Pressure: Always clean with reduced air pressure. An air pressure no greater than 15 to 20 psi will allow quick and thorough cleaning of the cup and gun and at the same time will:

1. Minimize the amount of solvent atomized into the air.
2. Prevent possibility of damage to cup from excessive back pressure.
3. Reduce the force with which solvent is expelled from the vent.

Cleaning Procedures:

1. Empty paint from cup and add small amount of clean solvent. The amount required will vary with different coatings and solvents.
2. Shake cup to wash down inside surfaces. Then spray solvent at low air pressure (15-20 psi) to flush out fluid passages.
3. Pour out solvent and add same amount of clean solvent.
- 4a. Again, shake cup. Loosen air cap. Hold a folded cloth over front of gun and invert cup over solvent receptacle. Trigger with short bursts to back flush vent channel. With valve in the **D/F** position, solvent will be expelled with force from the channel vent hole in lid.

Alternative to Step 4a.

- 4b. Shut off air to gun. With valve in the **D/F** position, invert cup over solvent receptacle. Trigger gun. Allow solvent to drip out channel vent hole in lid for several seconds, or until clean solvent is seen.

IMMERSION

Since all materials in the cup are highly solvent resistant, the cup assembly may be immersed for cleaning. Immersion should not exceed 24 hours. The use of paint strippers should be avoided because strippers will affect the aluminum as well as other non-metallic components. If the lid gasket has become swollen from prolonged exposure to solvents, it will return to its original size without loss of properties when allowed to dry.

Figure 4 Gun Drawing

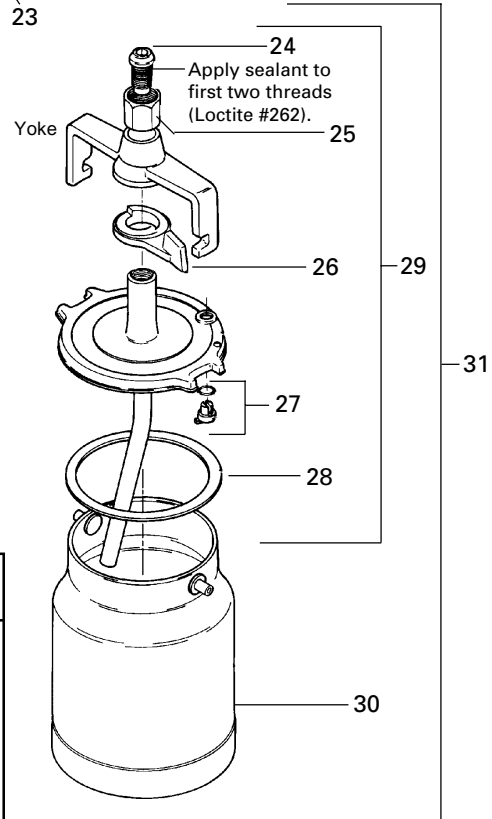
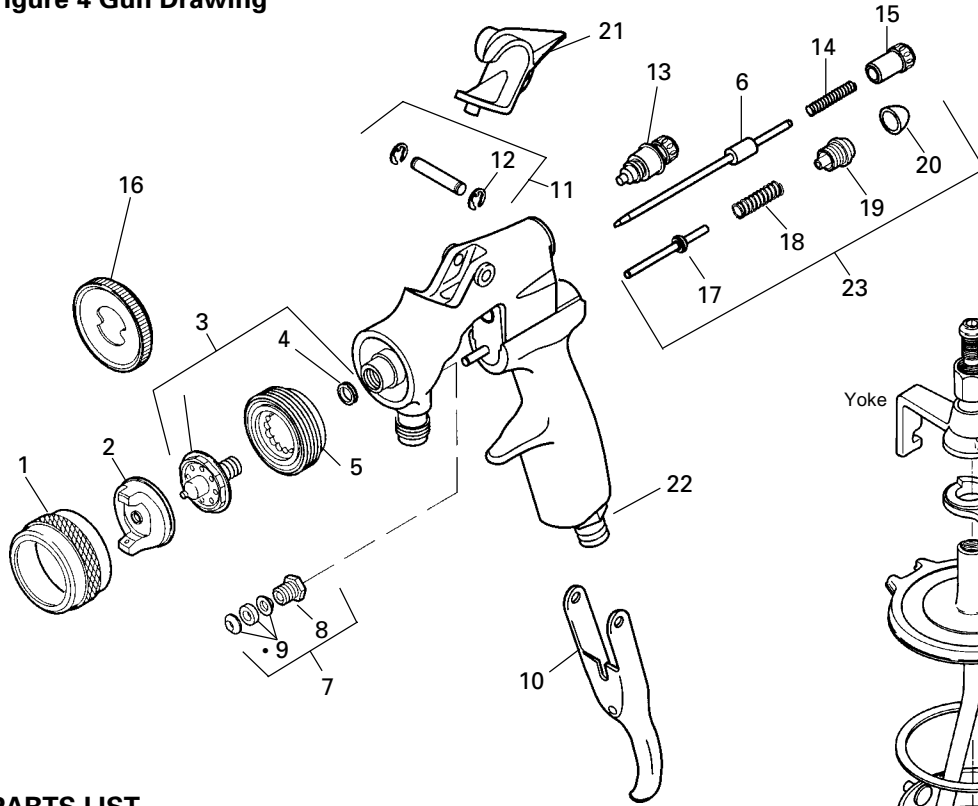

PARTS LIST

Ref. No.	Computer Part No.	Replacement Part No.	Description	Ind. Parts Required
1	690002	FLG-101-K2	Retaining Ring (Kit of 2)	1
2	---	See Chart 1	Air Cap	1
3	---	See Chart 1	Fluid Tip, Seal and Tip Tool	1
*4	690015	FLG-4-1-K5	Fluid Tip Seal (Kit of 5)	1
5	690007	FLG-105	Baffle	1
6	690011	FLG-431	Fluid Needle	1
*7	690012	FLG-440-K5	Packing Kit (includes 1 packing nut and 5 packing sets)	1
*8	---	---	Packing Nut	1
9	192109	JGA-4035-K5	Packing Kit (Kit of 15)	1
10	519132	FLG-412	Trigger	1
*11	519029	FLG-8-K2	Trigger Stud Kit (Kit of 2)	1
*12	---	---	Circlip	2
13	690010	FLG-416	Spreader Adjustment Valve	1
*14	---	---	Spring	1
*15	690008	FLG-109-K2	Needle Adjusting Screw (Kit of 2)	1
*16	690009	FLG-111-K2	Fluid Tip Tool (Kit of 2)	1
*17	---	---	Air Valve Stem and Seal	1
*18	---	---	Air Valve Spring	1
*19	---	---	Air Valve Cap Body	1
*20	---	---	Air Valve Cap	1
21	---	---	Gun Hook	1
22	519054	FLG-40	Air Inlet Adapter	1
23	519134	FLG-414	Air Valve Service Kit	1
+24	---	---	Adapter, 1/2" NPS (M)	1
+25	---	---	Nut, 3/8" NPS (F)	1
+26	---	---	Cam	1
+27	190924	TGC-407-1-K3	Drip Free Valve & Gasket (Kit of 3)	1
+28	190391	TGC-9-K5	**Tri Seal® Lid Gasket (Kit of 5)	1
29	190381	TGC-404	Lid Assembly (Quart)	1
30	190221	KR-428-2	Suction Cup Assembly (Quart)	1
31	120011	TGC-545	Suction Cup Assembly (includes Ref. Nos. 24-30)	1

Figure 5 - Cup Drawing



• (Ref. No. 9) Needle Packing Assembly. Detailed 3-piece drawing.

* A quantity of necessary parts is included in Repair Kit FLG-480 (Computer No. 690013) for complete gun repair and should be kept on hand for service convenience.





+ KK-5007 Repair Kit includes Ref. Nos. 24-28. Repair kit contains enough parts to repair one complete assembly.

Chart 1 For Model Numbers FLG-513, FLG-606 and FLG-626 Spray Guns

Spray Gun Model Number	Spray Gun Computer Number	No. on Air Cap	Ref. No. 2 Air Cap		Ref. No. 3 Fluid Tip		Fluid Tip Size
			Part No.	Computer No.	Part No.	Computer No.	
FLG-513-316	611104	3	FLG-1-3	690001	FLG-102-16K	690004	1.6 (Std.)
FLG-606-116	611100	1	FLG-1-1	690000	FLG-102-16K	690004	1.6 (Std.)
FLG-626-322	611102	3	FLG-1-3	690001	FLG-102-22K	690006	2.2 (Std.)
					FLG-102-18K	690005	1.8 (Std.)
					FLG-102-14K	690003	1.4 (Opt.)

Optional tips for FLG guns available as service parts only.

TROUBLESHOOTING





CONDITION	CAUSE	CORRECTION
Heavy top or bottom pattern 	Horn holes plugged. Obstruction on top or bottom of fluid tip. Cap and/or tip seat dirty.	Clean. Ream with non-metallic point. Clean. Clean.
Heavy right or left side pattern 	Left or right side horn holes plugged. Dirt on left or right side of fluid tip. Remedies for the top-heavy, bottom-heavy, right-heavy, and left-heavy patterns: 1. Determine if the obstruction is on the air cap or the fluid tip. Do this by making a test spray pattern. Then, rotate the cap one-half turn and spray another pattern. If the defect is inverted, obstruction is on the air cap. Clean the air cap as previously instructed. 2. If the defect is not inverted, it is on the fluid tip. Check for a fine burr on the edge of the fluid tip. Remove with #600 wet or dry sand paper. 3. Check for dried paint just inside the opening; remove by washing with solvent.	Clean. Ream with non-metallic point. Clean.
Heavy center pattern 	Fluid flow too high for atomization air (pressure feed). Material flow exceeds air cap's capacity. Spreader adjustment valve set too low. Atomizing pressure too low. Material too thick.	Balance air pressure and fluid pressure. Increase spray pattern width with spreader adjustment valve. Thin or lower fluid flow. Adjust. Increase pressure. Thin to proper consistency.
Split spray pattern 	Fluid adjusting knob turned in too far. Atomization air pressure too high. Fluid pressure too low (pressure feed only). Spreader adjusting valve set too high.	Back out counterclockwise to achieve proper flow. Reduce at transformer or gun. Increase fluid pressure (increases gun handling speed). Adjust.
Jerky or fluttering spray 	*Loose or damaged fluid tip/seat. Material level too low. Container tipped too far. Obstruction in fluid passage. Loose or broken fluid tube or fluid inlet nipple. Dry or loose fluid needle packing nut.	Tighten or replace. Refill. Hold more upright. Backflush with solvent. Tighten or replace. Lubricate or tighten.
Unable to get round spray	Fan adjustment screw not seating properly. Air cap retaining ring loose.	Clean or replace. Tighten.
Will not spray	No air pressure at gun. Internal mix or pressure feed air cap and tip used with suction feed. Fluid pressure too low. Fluid needle adjusting screw not open enough. Fluid too heavy for gravity feed.	Check air supply and air lines. Change to proper suction feed air cap and tip. Increase fluid pressure at tank. Open fluid needle adjusting screw. Thin material and/or change to larger tip size.
Starved spray pattern	Inadequate material flow. Low atomization air pressure.	Back fluid adjusting screw out to first thread, or increase fluid pressure at tank, or change to larger tip size. Increase air pressure and rebalance gun.
Excessive overspray	Too much atomization air pressure. Gun too far from work surface. Improper stroking (arcing, gun motion too fast).	Reduce pressure. Adjust to proper distance. Move at moderate pace, parallel to work surface.
Excessive fog	Too much or too fast-drying thinner. Too much atomization air pressure.	Remix properly. Reduce pressure.
Dry spray	Air pressure too high. Gun tip too far from work surface. Gun motion too fast. Gun out of adjustment.	Decrease air pressure. Adjust to proper distance. Slow down. Adjust.

*Most common problem.

TROUBLESHOOTING (continued)

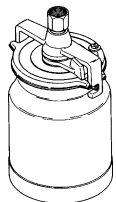
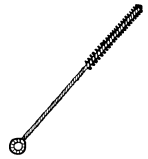
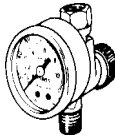
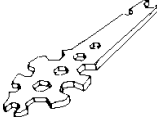
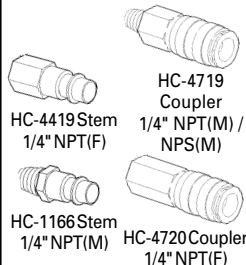
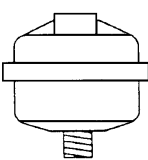
CONDITION	CAUSE	CORRECTION
Fluid leaking from packing nut	Packing nut loose. Packing worn or dry.	Tighten, do not bind needle. Replace or lubricate.
Fluid leaking or dripping from front of gun	Packing nut too tight. Dry packing. Fluid tip or needle worn or damaged. Foreign matter in tip. Fluid needle spring broken. Wrong size needle or tip.	Adjust Lubricate. Replace tip & needle. Clean. Replace. Replace.
Runs and sags	Too much material flow. Material too thin. Gun tilted on an angle or gun motion too slow.	Adjust gun or reduce fluid pressure. Mix properly or apply light coats. Hold gun at right angle to work and adapt to proper gun technique
Thin, sandy coarse finish drying before it flows out	Gun too far from surface. Too much air pressure. Improper thinner being used.	Check distance. Normally 6-8". Reduce air pressure and check spray pattern. Follow paint manufacturer's mixing instructions.
Thick, dimpled finish "orange peel".	Gun too close to surface. Too much material coarsely atomized. Air pressure too low. Improper thinner being used. Material not properly mixed. Surface rough, oily, dirty.	Check distance. Normally 6-8". Turn in fluid adjusting screw or reduce fluid pressure or change to a smaller tip size. Increase air pressure or reduce fluid pressure. Follow paint manufacturer's mixing instructions. Follow paint manufacturer's mixing instructions. Properly clean and prepare.

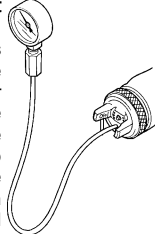
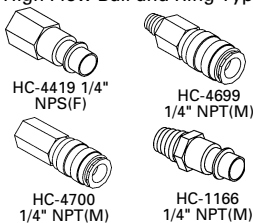
ACCESSORIES

<p>TGC-545 Aluminum TLC-555 (Teflon Lined) Drip Free Suction Cups</p>  <p>Cups have a unique, two position valve which permits selection of either a drip free or conventional open vent mode.</p>	<p>KK-700-K10 (10 ea.) 3/8" & 5/8" Cleaning Brushes</p>  <p>These brushes are helpful in cleaning threads and recesses of gun body.</p>	<p>HAV-500 OR HAV-501 Adjusting Valve (HAV-501 SHOWN)</p>  <p>HAV-500 does not have pressure gauge. Use to control air usage at gun.</p>	<p>WR-103 Wrench</p>  <p>Contains all necessary tip, hose and nut sizes used on or with gun.</p>	<p>Automotive Quick Connects For HVLP Guns (Air) High Flow Type.</p>  <p>HC-4419 Stem 1/4" NPT(F) HC-4719 Coupler 1/4" NPT(M) / NPS(M) HC-1166 Stem 1/4" NPT(M) HC-4720 Coupler 1/4" NPT(F)</p>
<p>HAF-507 Whirlwind™ In-Line Air Filter</p>  <p>Removes water, oil, and debris from the air line.</p>	<p>MSP-524 Twin Cartridge, Paint Spray Respirator</p>  <p>NIOSH-Certified (TC-84A-1623) for respiratory protection in atmospheres not immediately dangerous to life.</p>	<p>FLG-463 Air Cap Test Kit (#3 Air Cap)</p>  <p>The purpose of this test kit is to measure air cap atomizing air pressure at the center air port of the air cap. Used to confirm code compliance and as a daily quality control measure.</p>	<p>Industrial Quick Connects Approved for HVLP Guns (Air) High Flow Ball and Ring Type</p>  <p>HC-4419 1/4" NPS(F) HC-4699 1/4" NPT(M) HC-4700 1/4" NPT(M) HC-1166 1/4" NPT(M)</p>	
<p>Spray Gun Lube SSL-10 (2 oz. bottle)</p>  <p>Compatible with all paint materials; contains no silicone or petroleum distillates to contaminate paint. MSDS available upon request.</p>				

DeVILBISS WORLDWIDE SALES AND SERVICE LISTING - www.devilbiss.com

INDUSTRIAL FINISHING - DeVilbiss has authorized distributors throughout the world. **FOR TECHNICAL ASSISTANCE OR THE DISTRIBUTOR NEAREST YOU, CALL TOLL FREE 1-888-992-4657 (U.S.A. AND CANADA ONLY). FOR LOCAL CALLS, SEE LISTING BELOW.**

U.S./Canada Sales & Customer Service Office
GLENDALE HEIGHTS, IL 60139

Address
195 Internationale Blvd.

Telephone No.
(630) 237-5000
Toll Free Fax No. 1-877-790-6965

AUTOMOTIVE REFINISHING - DeVilbiss has authorized distributors throughout the world. For equipment, parts and service, check the Yellow Pages under "Automobile Body Shop Equipment and Supplies". **FOR TECHNICAL ASSISTANCE, CALL TOLL FREE 1-800-445-3988 (U.S.A. ONLY). FOR LOCAL CALLS, SEE LISTING BELOW.**

U.S. Customer Service Office
MAUMEE, OH 43537

Address
1724 Indian Wood Circle

Telephone No.
(419) 891-8100
Toll Free Fax No. 1-800-445-6643



An Illinois Tool Works Company