

**DEVILBISS**  
*The Right Way To Finish™*

SERVICE BULLETIN  
**SB-2-001-F**  
Replaces SB-2-001-E

## **SPRAY GUN TROUBLESHOOTING AND PREVENTIVE MAINTENANCE GUIDE**



**IMPORTANT:** Before using this equipment, read all safety precautions and instructions in this manual. Keep for future use.

### SAFETY PRECAUTIONS

This manual contains information that is important for you to know and understand. This information relates to USER SAFETY and PREVENTING EQUIPMENT PROBLEMS. To help you recognize this information, we use the following symbols. Please pay particular attention to these sections.



**Important safety information - A hazard that may cause serious injury or loss of life.**




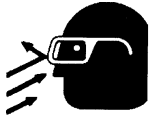


**Important information that tells how to prevent damage to equipment, or how to avoid a situation that may cause minor injury.**

**Note**

Information that you should pay special attention to.



**The following hazards may occur during the normal use of this equipment. Please read the following chart before using this equipment.**

HAZARD	CAUSE	SAFEGUARDS
<p><b>Fire</b></p> 	<p>Solvent and coatings can be highly flammable or combustible especially when sprayed.</p>	<p>Adequate exhaust must be provided to keep air free of accumulations of flammable vapors.</p> <p>Smoking must never be allowed in the spray area.</p> <p>Fire extinguishing equipment must be present in the spray area.</p>
<p><b>Solvent Spray</b></p> 	<p>During cleaning and flushing, solvents can be forcefully expelled from fluid fluid and air passages. Some solvents can cause eye injury.</p>	<p>Wear eye protection.</p>
<p><b>Inhaling Toxic Substances</b></p> 	<p>Certain materials may be harmful if inhaled, or if there is contact with the skin.</p>	<p>Follow the requirements of the Material Safety Data Sheet supplied by your coating material manufacturer.</p> <p>Adequate exhaust must be provided to keep the air free of accumulations of toxic materials.</p> <p>Use a mask or respirator whenever there is a chance of inhaling sprayed materials. The mask must be compatible with the material being sprayed and its concentration. Equipment must be as prescribed by an industrial hygienist or safety expert, and be NIOSH approved.</p>
<p><b>Explosion Hazard Incompatible Materials</b></p> 	<p>Halogenated hydrocarbon solvents - for example; methylene chloride and 1, 1, 1 - Trichloroethane are not chemically compatible with the aluminum that might be used in many system components. The chemical reaction caused by these solvents reacting with aluminum can become violent and lead to an equipment explosion.</p>	<p>Guns with stainless steel internal passageways may be used with these solvents. However, aluminum is widely used in other spray application equipment - such as material pumps, cups and regulators, valves, etc. Check all equipment items before use and make sure they can also be used safely with these solvents. Read the label or data sheet for the material you intend to spray. If in doubt as to whether or not a coating or cleaning material is compatible, contact your material supplier.</p>

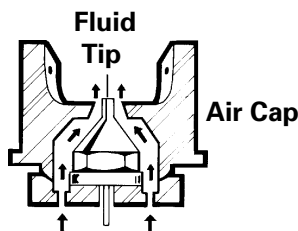
**PRINCIPLES OF AIR SPRAY**

Spray application is perhaps the simplest method of coating where a sizeable area or volume of material is involved or when intricate shapes and irregular surfaces require painting. Spray will give the most uniform film thickness making it easy to obtain a smooth finish.

The air spray gun is a tool which uses compressed air to atomize paint, or other sprayable material, and to apply it to a surface. Air and material enter the gun through separate passages, and are mixed at the air cap in a controlled pattern. Air spray guns may be classified in various ways. Two ways of classifying guns are by the location of the material container and the material feed system. **Figure 1** shows a gun with a cup attached below. This is called **Suction Feed** which draws material to the gun by suction. **Figure 3** is a gun with a cup attached above. This is called **Gravity Feed** - the material travels down, carried by gravity. **Figure 4** shows a material container some distance away from the spray gun. This is **Pressure Feed** - the material is fed by positive pressure. Suction feed is easily identified by the fluid tip extending slightly beyond the face of the air cap, as shown in **Figure 2**. Suction feed guns are suited to many color changes and to small amounts of material, such as in touchup or lower production operations.

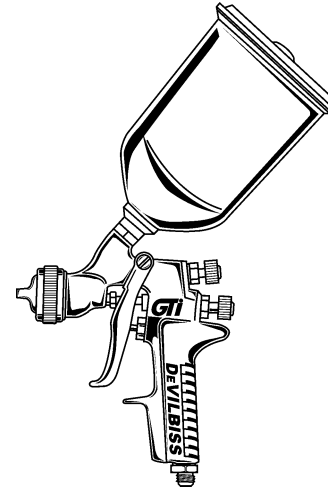


**Figure 1 Suction Feed Gun with Attached Cup**

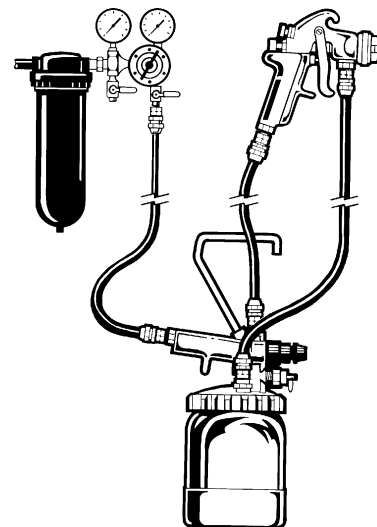


**Figure 2 Suction Feed Air Cap**

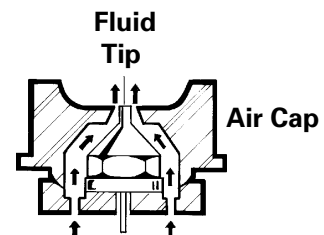
**Figure 3 Gravity Feed Gun With Cup on Top**



Gravity feed guns are ideal for small applications such as spot repair, detail finishing or for finishing in a limited space. They require less air than a suction feed gun and usually have less overspray.



**Figure 4 Typical Pressure Feed Gun With Remote Cup**



**Figure 5 Pressure Feed Air Cap**

A pressure feed system is normally used when large quantities of material are to be applied, when the material is too heavy to be siphoned from a container or when fast application is required.

### Internal and External Mix Guns

An external mix gun mixes and atomizes air and fluid outside the air cap. It can be used for applying all types of materials, and it is particularly desirable when spraying fast-drying paints such as lacquer. It is also used when a high quality finish is desired.

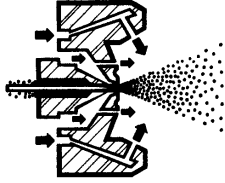


Figure 6 External Mix Gun

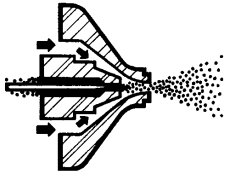


Figure 7 Internal Mix Gun

This gun mixes air and material inside the air cap, before expelling them. It is normally used where low air pressures and volumes are available, or where slow-drying materials are being sprayed. A typical example is spraying flat wall paint, or outside house paint, with a small compressor. Internal mix guns are rarely used for finishing when a fast-drying material is being sprayed, or when a high quality finish is required.

### HVLP (High-Volume/Low-Pressure)

HVLP uses a high volume of air (typically between 15-22 CFM) delivered at low pressure (10 psi or less) to atomize paint into a soft, low-velocity spray pattern.

As a result, far less material is lost in overspray, bounce-back than with conventional air spray. This is why HVLP delivers a dramatically higher transfer efficiency (the amount of material that is actually applied to the part) than higher pressure spray systems.

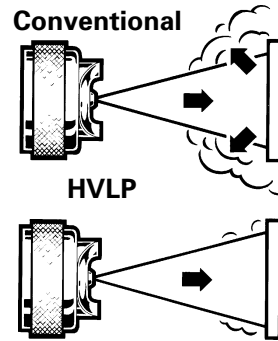


Figure 8 Air Cap Overspray, Conventional/HVLP

The HVLP spray gun resembles a standard spray gun in shape and operation.

HVLP is growing in popularity and it has also been judged environmentally acceptable due to its high transfer efficiency.

HVLP can be used with low to-medium solid materials, including two-component paints, urethanes, acrylics, epoxies, enamels, lacquers, stains, primers, etc. More recently developed HVLP air caps can also satisfactorily atomize even high solid coatings.

### OPERATION

#### Suction and Gravity Feed Equipment Hook-Up

Connect the air supply from the compressor outlet to the air filter regulator inlet. Connect the air supply hose from the regulator outlet to the air inlet on the spray gun. After the material has been reduced to proper consistency, thoroughly mixed and strained into the cup, attach the gun to the cup.

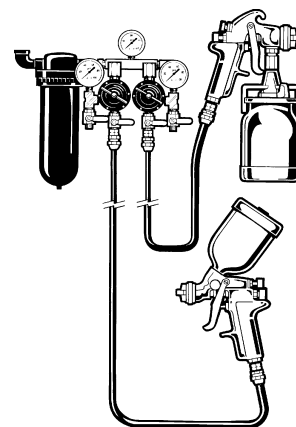
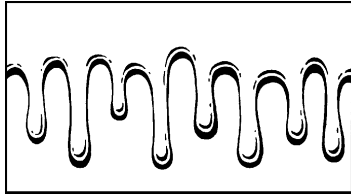


Figure 9 Suction Feed & Gravity Feed System Components

Spray a horizontal test pattern (air cap horns in a vertical position). Hold the trigger open until the paint begins to run. There should be even distribution of the paint across the full width of the pattern (see Figure 11). Adjust with fan pattern adjustment.

If distribution is not even, there is a problem with either the air cap or the fluid tip. Refer to the **TROUBLESHOOTING** section for examples of faulty patterns to help diagnose the problem.

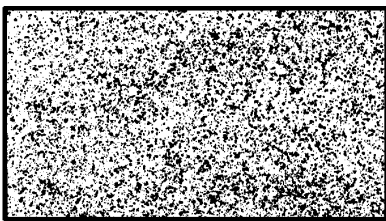


**Figure 10 Horizontal Test Pattern with Even Material Distribution**

If the pattern produced by the above test appears normal, rotate the air cap back to a normal spraying position and begin spraying (Example - a normal pattern with a #9000 air cap will be about 9" long when the gun is held 8" from the surface.) With the fluid adjusting screw open to the first thread and the air pressure set at approximately 30 psi, make a few test passes with the gun on some clean paper. Move the gun faster than usual when spraying the test passes. If there are variations in particle size - specks and/or large globs, the paint is not atomizing properly (See Figure 12). If the paint is not atomizing properly, increase the air pressure slightly and make another test pass. Continue this sequence until the paint particle size is uniform.

If the pattern seems starved for material and the fluid adjusting screw is open wide (to the first thread), the atomization air pressure may be too high, or the material may be too heavy. Recheck the viscosity or reduce the air pressure.

If the material is spraying too heavily and sagging, reduce the material flow by turning in the fluid adjusting screw (clockwise).



**Figure 11 Pattern with Uneven Particle Size**

### Pressure Feed Components

A pressure feed system consists of a pressure feed spray gun, pressure feed tank, cup or pump, an air filter/regulator, appropriate air and fluid hoses and an air compressor.

Connect the air hose from the air regulator to the air inlet on the gun. Connect the mainline air hose to the air inlet on the tank, cup or pump.

### WARNING

**To avoid hazardous bursting or equipment damage, do not exceed the container's maximum working pressure.**

Connect the fluid hose from the fluid outlet on the tank or pump to the fluid inlet on the gun.

Open spreader adjustment valve for maximum pattern size. Open fluid adjustment screw until the first thread is visible.

Shut off atomization air to the gun. Set the fluid flow rate by adjusting the air pressure in the material container. Use about 6 psi for a remote cup and about 15 psi for a 2-gallon, or larger, container. Adjust the fluid flow in the following ways:

Remove the air cap. With atomization air **off**, pull the trigger, flowing material into a clean, graduated container for 10 seconds. Measure the amount of material which flowed in that time and multiply times 6 (or flow for 30 seconds and multiply time 2). This is the fluid flow rate in ounces per minute. For standard finishing, it should be about 14 to 16 ounces per minute. If the flow rate is less than this, increase the air pressure in the container and repeat.

When the flow rate is correct, reinstall the air cap. If fluid pressure at the tank, cup or pump exceeds 20 psi, the next larger fluid tip size should be used.

Turn the atomization air to about 30 psi at the gun. Spray a fast test pattern on a clean sheet of paper and check the consistency of the particle size. Increase or decrease the air pressure until even particle size is achieved.

Spray a horizontal test pattern holding the trigger open until the material begins to run. Paint distribution across the full width of the pattern should be the same (adjust with fan pattern adjustment). If it cannot be adjusted, there may be a problem with either the air cap or the fluid tip which must be corrected. Refer to the Troubleshooting Section.

### Hints for good spray technique.

Hold gun perpendicular 6" to 8" (HVLV guns) or 8"-10" (suction, gravity or pressure conventional feed guns) to surface being sprayed.

Don't tilt the gun in any direction. This will result in uneven paint build causing runs and sags.

Trigger gun just before the edge of the surface to be sprayed. The trigger should be held fully depressed and the gun moved in one continuous motion, until the other edge of the object is reached. Release the trigger but continue the motion for a few inches until it is reversed for the return stroke.

Overlap each stroke 50%. Less than 50% will result in streaks on the finished surface. Move the gun at a constant speed while triggering since the material flows at a constant rate.

Another technique of triggering is referred to as "feathering". Feathering allows the operator to limit fluid flow by applying only partial trigger travel.

Spray edges and corners first. This is called banding. Banding reduces overspray yet provides good coverage on corners.

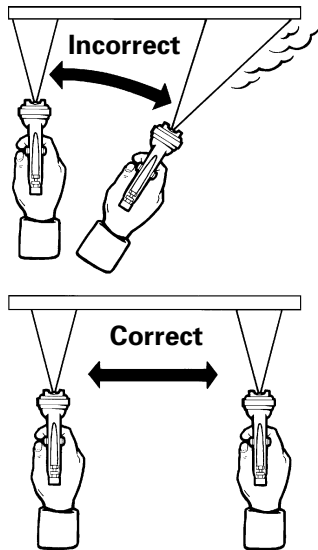


Figure 12 Spray Techniques

## REPLACEMENT OF PARTS

Follow specific gun Service Bulletin exploded view for replacing parts. There are areas requiring proper sequence.

The fan adjustment assembly should only be installed after turning the knob out. If left in, the stem or needle could jam against the seat.

Pull trigger or remove fluid adjusting screw prior to tip tightening. Tip and needle damage can occur.

Spray guns have some combination of plastic, copper, leather and soft packings and gaskets. It is recommended that these be replaced if the assembly is removed or when doing an overall repair. The fluid needle packing must be replaced when the packing nut bottoms out.

It is recommended to oil a new packing or needle before assembly. Packing nuts should be tightened just enough to seal (fluid leakage on pressure feed, suction of air on suction feed). Too tight will bind the needle as well as shorten life of packing. When replacing the fluid tip or fluid needle, it is recom-

mended to replace both at the same time. Lapped sets are available for most guns on pressure feed combinations.

## MAINTENANCE

**AIR CAP** - Remove the air cap from the gun and immerse it in clean solvent. Blow it dry with compressed air.

If the small holes become clogged, soak the cap in clean solvent. If reaming the holes is necessary, use a toothpick, a broomstraw or some other soft implement.

Do not clean holes with a wire, a nail or a similar hard object. Doing so could permanently damage the cap by enlarging the jets, resulting in a defective spray pattern.

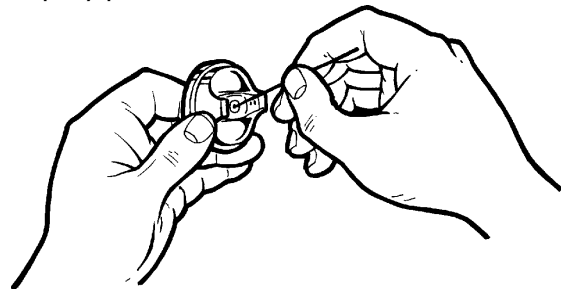


Figure 13 Cleaning Air Cap

**Suction or Pressure Feed Cleaning** - A suction or pressure feed gun with attached cup should be cleaned as follows:

Turn off the air to the gun, loosen the cup cover and remove the fluid tube from the paint. Holding the tube over the cup, pull the trigger to allow the paint to drain back into the cup.

Empty the cup and wash it with clean solvent and a clean cloth. Clean off the outside of the tube. Fill halfway with clean solvent and spray it through the gun to flush out the fluid passages. **Be sure to comply with local codes regarding solvent disposal.**

Then remove the air cap, clean it as previously explained and replace it on the gun.

Wipe off the gun with a solvent soaked cloth, or if necessary, brush the air cap and gun with a fiber brush using clean-up liquid or thinner.

**Cleaning a pressure feed gun with remote cup or tank** - Turn off air supply to cup or tank. Release material pressure from the system by opening relief valve. Material in hoses may be blown back. Lid must be loose and all air pressure off. Keep gun higher than container, loosen air cap approximately 2-3 turns, hold rag over air cap, and trigger gun until atomizing air forces all material back into the pressure vessel.

A gun cleaner may be used for either type of gun. This is an enclosed boxlike structure (vented) with an array of cleaning nozzles inside.

Guns and cups are placed over the nozzles, the lid is closed, the valve is energized, and the pneumatically controlled solvent sprays through the nozzles to clean the equipment. The solvent is contained, and must be disposed of properly.

Some states' codes require the use of a gun cleaner and it is unlawful to discharge solvent into the atmosphere. Another efficient method of cleaning the hose and gun passages is with a "Gun & Hose Cleaner" device, such as the "SolventSaver".

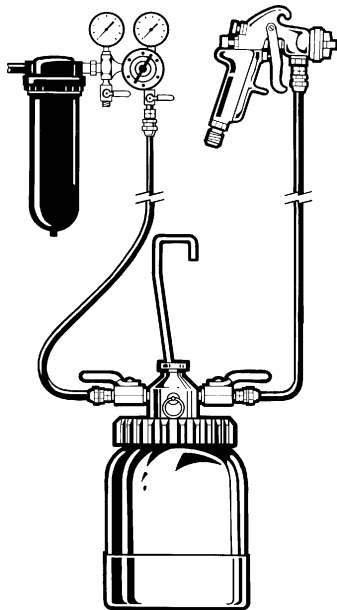


Figure 14 Using a Hose Cleaner

This device incorporates a highly efficient fluid header, which meters a precise solvent/air mixture. The cleaner operates with compressed air and sends a finely atomized blast of solvent through the fluid passages of the hose, the spray gun, etc.

This simple, easy to use cleaner speeds up equipment cleaning and saves solvent. It also reduces VOC emissions. **Be sure that both the hose cleaner and gun are properly grounded.**

Where local codes prohibit the use of a hose cleaner, manually backflush the hose into the cup or tank with solvent and dry with compressed air.

Clean the container and add clean solvent. Pressurize the system and run the solvent through until clean. Atomization air should be turned off during this procedure. **Be sure to comply with local codes regarding solvent dispersion and disposal.**

Clean the air cap, fluid tip and tank. Reassemble for future use.

#### Note

Never soak the entire gun in cleaning solvent. This will dry out the packings and remove lubrication.

#### LUBRICATION

Lubricate the fluid needle packing (A), the air valve packing (B) the trigger bearing screw (C) and the adjusting screw threads (D) with Spray Gun Lube, \*SSL-10, daily.

The fluid needle spring (E) should be lightly coated with petroleum jelly.

Thoroughly clean the air cap and baffle threads (F), and lubricate with spray gun lube, SSL-10, daily.

Lubricate each of these points after **every** cleaning in a gun washer.

\*A Material Safety Data Sheet is available from DeVilbiss upon request.

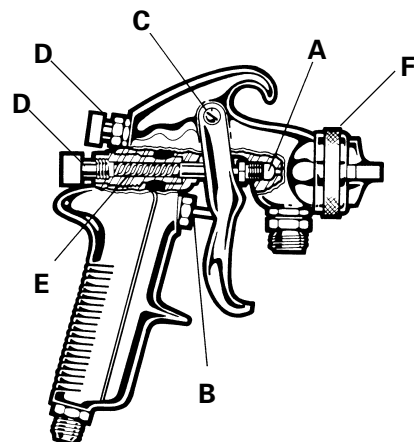







Figure 15 Lubrications Points



## TROUBLESHOOTING

CONDITION	CAUSE	CORRECTION
<b>Heavy top or bottom pattern</b> 	<p>Horn holes plugged.</p> <p>Obstruction on top or bottom of fluid tip.</p> <p>Cap and/or tip seat dirty.</p>	<p>Clean. Ream with non-metallic point.</p> <p>Clean.</p> <p>Clean.</p>
<b>Heavy right or left side pattern</b> 	<p>Left or right side horn holes plugged.</p> <p>Dirt on left or right side of fluid tip.</p> <p>Remedies for the top-heavy, bottom-heavy, right-heavy and left-heavy patterns:  1) Determine if the obstruction is on the air cap or the fluid tip. Do this by making a test spray pattern. Then, rotate the cap one-half turn and spray another pattern. If the defect is inverted, obstruction is on the air cap. Clean the air cap as previously instructed.  2) If the defect is not inverted, it is on the fluid tip. Check for a fine burr on the edge of the fluid tip. Remove with #600 wet or dry sand paper.  3) Check for dried paint just inside the opening. Remove paint by washing with solvent.</p>	<p>Clean. Ream with non-metallic point.</p> <p>Clean.</p>
<b>Heavy center pattern</b> 	<p>Fluid pressure too high for atomization air (pressure feed)).</p> <p>Material flow exceeds air cap's capacity.</p> <p>Atomizing pressure too low.</p> <p>Material too thick.</p>	<p>Balance air and fluid pressure. Increase spray pattern width with spreader adjustment valve.</p> <p>Thin or lower fluid flow.</p> <p>Increase pressure.</p> <p>Thin to proper consistency.</p>
<b>Split spray pattern</b> 	<p>Fluid adjusting knob turned in too far.</p> <p>Atomization air pressure too high.</p> <p>Fluid pressure too low (pressure feed only).</p> <p>Spreader adjusting valve set too high.</p>	<p>Back out counterclockwise to achieve proper pattern.</p> <p>Reduce at transformer.</p> <p>Increase fluid pressure.</p> <p>Adjust.</p>
<b>Jerky or fluttering spray</b> 	<p><b>Suction And Pressure Feed</b></p> <p>*Loose or damaged fluid tip/seat.</p> <p>Material level too low.</p> <p>Container tipped too far.</p> <p>Obstruction in fluid passage.</p> <p>Loose or broken fluid tube or fluid inlet nipple.</p> <p>Dry or loose fluid needle packing nut.</p>	<p>Tighten or replace.</p> <p>Refill.</p> <p>Hold more upright.</p> <p>Backflush with solvent.</p> <p>Tighten or replace.</p> <p>Lubricate or tighten.</p>

\*Most common problem.



CONDITION	CAUSE	CORRECTION
<b>Jerky or fluttering spray</b> <i>(continued)</i>	<b>Suction Feed Only</b> Material too heavy.  Container tipped too far.  Air vent in cup lid clogged.  Loose, damaged or dirty lid.  Dry or loose fluid needle packing.  Fluid tube resting on cup bottom.  Damaged gasket behind fluid tip.	Thin or replace.  Hold more upright.  Clear vent passage.  Tighten, replace or clean coupling nut.  Lubricate or tighten packing nut.  Tighten or shorten.  Replace gasket.
<b>Unable to get round spray</b>	Fan adjustment screw not seating properly.  Air cap retaining ring loose.	Clean or replace.  Tighten.
<b>Will not spray</b>	No air pressure at gun.  Internal mix or pressure feed air cap and tip used with suction feed.  Fluid pressure too low with internal mix cap and pressure tank.  Fluid needle adjusting screw not open enough.  Fluid too heavy for suction feed.	Check air supply and air lines.  Change to proper suction feed air cap and tip.  Increase fluid pressure at tank.  Open fluid needle adjusting screw.  Thin material or change to pressure feed.
<b>Starved spray pattern</b>	Inadequate material flow.  Low atomization air pressure (suction feed).	Back fluid adjusting screw out to first thread, or increase fluid pressure at tank.  Increase air pressure and re-balance gun.
<b>Excessive overspray</b>	Too much atomization air pressure  Gun too far from work surface.  Improper stroking (arcing, gun motion too fast).	Reduce pressure.  Adjust to proper distance.  Move at moderate pace, parallel to work surface.
<b>Excessive fog</b>	Too much, or too fast-drying thinner.  Too much atomization air pressure.	Remix properly.  Reduce pressure.

<b>CONDITION</b>	<b>CAUSE</b>	<b>CORRECTION</b>
<b>Dry Spray</b>	<p>Air pressure too high.</p> <p>Material not properly reduced (suction feed).</p> <p>Gun tip too far from work surface.</p> <p>Gun motion too fast.</p> <p>Gun out of adjustment</p>	<p>Decrease air pressure.</p> <p>Reduce to proper consistency.</p> <p>Adjust to proper distance.</p> <p>Slow down.</p> <p>Adjust.</p>
<b>Fluid leaking from packing nut</b>	<p>Packing nut loose.</p> <p>Packing worn or dry</p>	<p>Tighten, do not bind needle.</p> <p>Replace or lubricate.</p>
<b>Fluid leaking or dripping from front of pressure feed gun</b>	<p>Packing nut too tight</p> <p>Dry packing.</p> <p>Fluid tip or needle worn or damaged</p> <p>Foreign matter in tip.</p> <p>Fluid needle spring missing or broken.</p> <p>Wrong size needle or tip.</p> <p>Needle bound by misaligned sprayhead, (MBC guns only).</p>	<p>Adjust</p> <p>Lubricate.</p> <p>Replace tip &amp; needle with lapped sets.</p> <p>Clean.</p> <p>Replace.</p> <p>Replace.</p> <p>Tap sprayhead perimeter with a wooden mallet. Retighten lock bolt.</p>
<b>Runs and sags</b>	<p>Too much material flow.</p> <p>Material too thin.</p> <p>Gun tilted on an angle.</p>	<p>Adjust gun or reduce fluid pressure.</p> <p>Mix properly or apply light coats.</p> <p>Hold gun at right angle to work and adapt to proper gun technique.</p>
<b>Thin, sandy coarse finish drying before it flows out</b>	<p>Gun too far from surface.</p> <p>Too much air pressure.</p> <p>Improper thinner being used.</p>	<p>Check distance. Normally 6-8" - HVLP, 8-10" - conventional.</p> <p>Reduce air pressure and check spray pattern.</p> <p>Follow paint manufacturer's mixing instructions.</p>
<b>Thick, dimpled finish "orange peel". Too much material coarsely atomized</b>	<p>Gun too close to surface.</p> <p>Air pressure too low.</p> <p>Improper thinner being used.</p> <p>Material not properly mixed.</p> <p>Surface rough, oily, dirty.</p>	<p>Check distance. Normally 6-8" - HVLP, 8-10" - conventional.</p> <p>Increase air pressure or reduce fluid pressure.</p> <p>Follow paint manufacturer's mixing instructions.</p> <p>Follow paint manufacturer's mixing instructions.</p> <p>Properly clean and prepare.</p>

# SYSTEM SOLUTIONS FOR YOUR SPRAY FINISHING NEEDS



More than just a spray gun manufacturer, DeVilbiss is your single source for practical solutions to all your spray finishing challenges.

To maximize your production output, you need consistent, reliable performance, high-quality results and a responsive service partner who knows the industry and your business. And with DeVilbiss, you not only get the equipment, you also get the expertise.

Since 1888, we've advanced the science of spray finishing by introducing innovative products and technological developments that set the standards for the industry. These efforts help ensure that we can deliver the best solution for your particular spray finishing applications.

## Spray Guns

- Conventional air spray and HVLP
- Standard-size, midsize, manual and automatic
- Waterborne compatible, stainless steel passages
- Shading and touch-up guns for precision control
- Decorative guns for textured finish
- Duster guns for tough cleaning applications
- Gravity feed, suction feed, pressure feed
- MAX™ the only true ergonomic spray gun

## Cups and Tanks

- Pressure, gravity and suction feed cups
- Aluminum, stainless steel and polyethylene
- ASME-certified galvanized and stainless tanks
- Tank capacities from 2 gallon to 15 gallon
- Air motor drives

## Air Control

- Regulators and gauges
- Adjusting valves
- Centrifugal, coalescing, in-line and desiccant filters

## Hose

- Fluid and air hose
- Ball and air-adjusting valves
- Fittings and connections

## Additional Accessories

- Thread Adapters
- SolventSaver™ gun and hose cleaners
- Gun-mounted fluid strainers
- Replacement parts kits
- Air cap test kits
- Fluid regulators

**DeVILBISS WORLDWIDE SALES AND SERVICE LISTING - [www.devilbiss.com](http://www.devilbiss.com)**

**INDUSTRIAL FINISHING**

DeVilbiss has authorized distributors throughout the world. **FOR TECHNICAL ASSISTANCE OR THE DISTRIBUTOR NEAREST YOU, CALL TOLL FREE 1-888-992-4657 (U.S.A. AND CANADA ONLY). FOR LOCAL CALLS, SEE LISTING BELOW.**

U.S./Canada Sales & Customer Service Office GLENDALE HEIGHTS, IL 60139	Address 195 Internationale Blvd.	Telephone No. (630) 237-5000 Toll Free Fax No. 1-877-790-6965
---	-------------------------------------	---

**AUTOMOTIVE REFINISHING**

DeVilbiss has authorized distributors throughout the world. For equipment, parts and service, check the Yellow Pages under "Automobile Body Shop Equipment and Supplies". **FOR TECHNICAL ASSISTANCE, CALL TOLL FREE 1-800-445-3988 (U.S.A. ONLY). FOR LOCAL CALLS, SEE LISTING BELOW.**

U.S. Customer Service Office MAUMEE, OH 43537	Address 1724 Indian Wood Circle	Telephone No. (419) 891-8100 Toll Free Fax No. 1-800-445-6643
--	------------------------------------	---

**DEVILBISS**

An Illinois Tool Works Company